









-  Transportwagen 5er Paket
-  Transport carriage 5 times package
-  Chariot de transport, lot de 5
-  Carrello da trasporto Pacchetto da 5

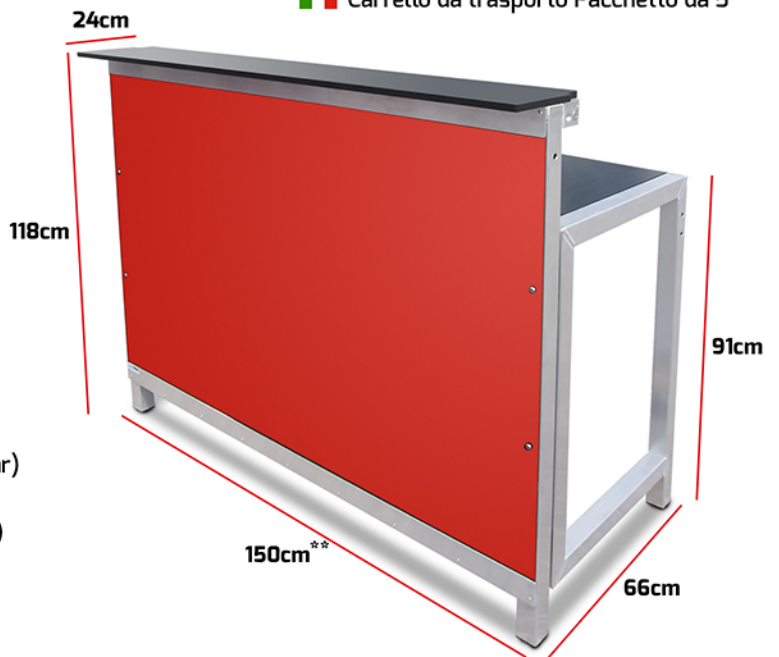

-  einschiebbare Frontplatte (seitlich herausnehmbar)
-  Removable front plate (sideways removable)
-  Panneau frontal insérable (retirable latéralement)
-  Piano frontale inseribile (estraibile lateralmente)



1.



2.







3.







4.

* = genaue Maß: 7,45 lfm
 ** = genaue Maß: 149 cm







-  Eckelement 90°
-  corner element 90°
-  élément d'angle 90°
-  Elemento angolare 90°

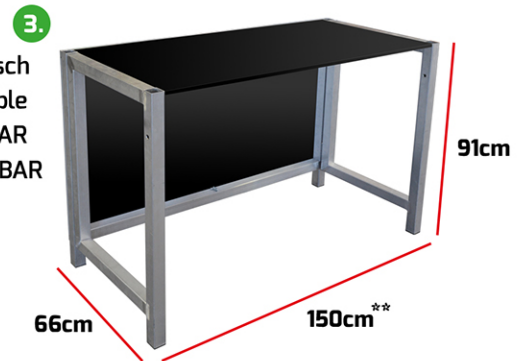





-  klappBAR Rückwand
-  klappBAR rear panel
-  paroi arrière klappBAR
-  parete posteriore klappBAR

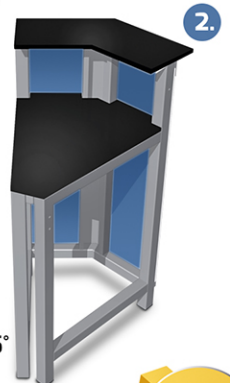
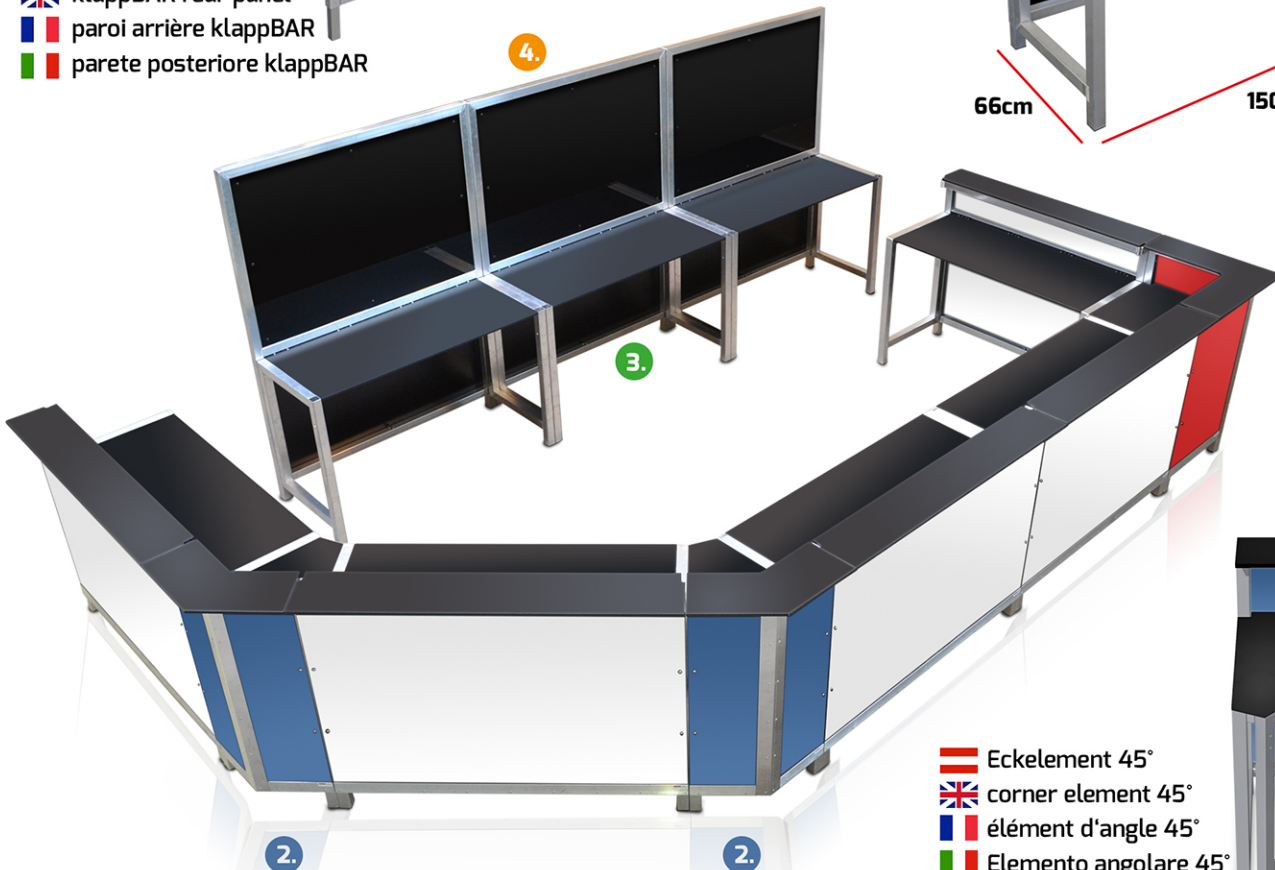

-  klappBAR Tisch
-  klappBAR table
-  table klappBAR
-  Tavolo klappBAR



-  Eckelement 45°
-  corner element 45°
-  élément d'angle 45°
-  Elemento angolare 45°

** = genaues Maß: 149 cm



2.

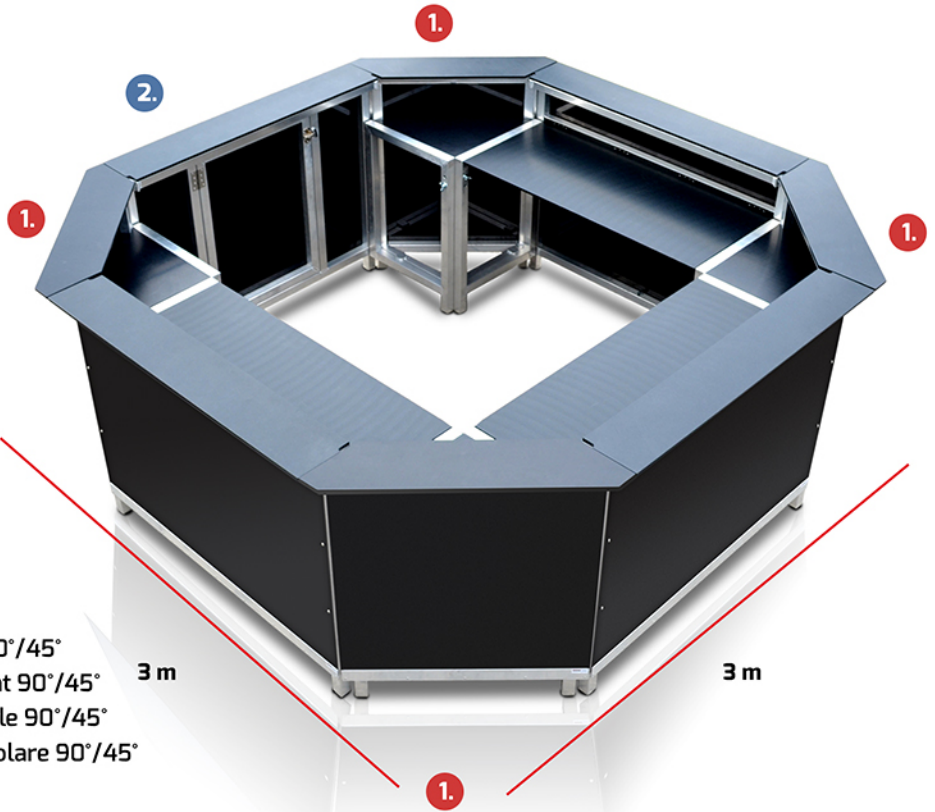

1.

2.

1.

1.





3 m

3 m





1.



1.

-  Eckelement 90°/45°
-  corner element 90°/45°
-  élément d'angle 90°/45°
-  Elemento angolare 90°/45°



-  Spezielle klappBAR Konstruktionen
-  Special klappBAR constructions
-  Constructions klappBAR spéciale
-  Costruzioni speciali klappBAR



-  Transportwagen
-  Transport carriage
-  Chariot de transport
-  Carello da trasporto

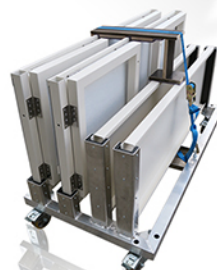
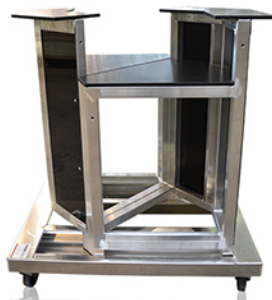



Arbeitsplatte und Bord aus hochverdichteten Kunststoffplatten

Highly-compressed plastic plate worktop and shelving

Comptoir et bord en panneaux plastique haute densité

Piani di lavoro e mensole realizzati con robuste lastre di plastica altamente compresse



CNC gefertigtes Aluminiumgelenk

CNC manufactured aluminium joint

Joint en aluminium usiné CNC

Giunto in alluminio lavorato CNC

Sonderprofile für Frontplatten

special profile for front panel

Profil spécial pour les panneaux avant

Profilo speciale per pannelli frontali

Gewicht: 47 kg

weight: 47 kg

Poids: 47 kg

peso: 47 kg

ALUVERBUND-Frontplatte zum einfachen austauschen

Aluminium composite front panel for simple change

Panneaux avant en aluminium composit pour simple échange

Pannello frontale composito in alluminio per semplicemente scambio

Kunststofffüße

plastic feet

Piedsen plastique

Piedini in plastica

Aluminium Sonderprofile mit abgerundeten Kanten

Aluminium special profile with rounded edges

Profilé spécial en aluminium avec bords arrondis

Profilo speciale in alluminio con

**Schweißverbindungen nach
ÖNORM EN ISO 9606-1/2**

- Massiv gefertigte Edelstahl Scharniere
- solid stainless steel hinges
- charnières en acier inoxydable
- cerniere in acciaio inox massiccio

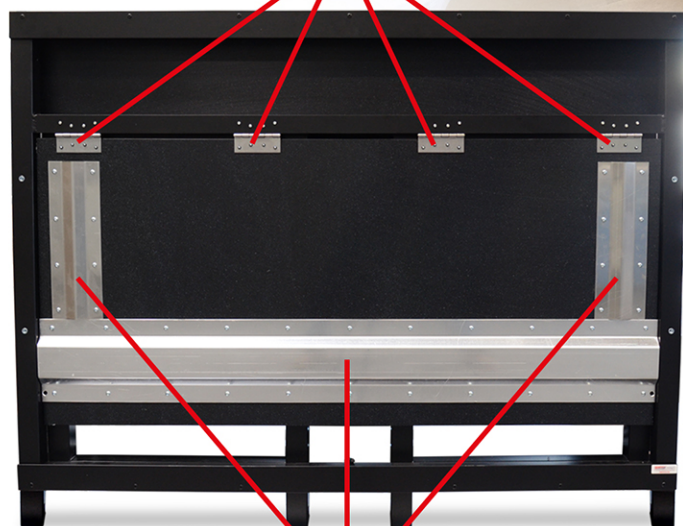

- Unterseite
- bottom
- Fond
- Fondo

- Arbeitsplatte mit Sonderprofile aus hochfesten Aluminium verstärkt
- worktop with special profile made of high-strength aluminium reinforced
- Comptoir avec profil spécial en aluminium renforcé haute résistance
- controsoffitto con profilo speciale in alluminio rinforzato ad alta resistenza





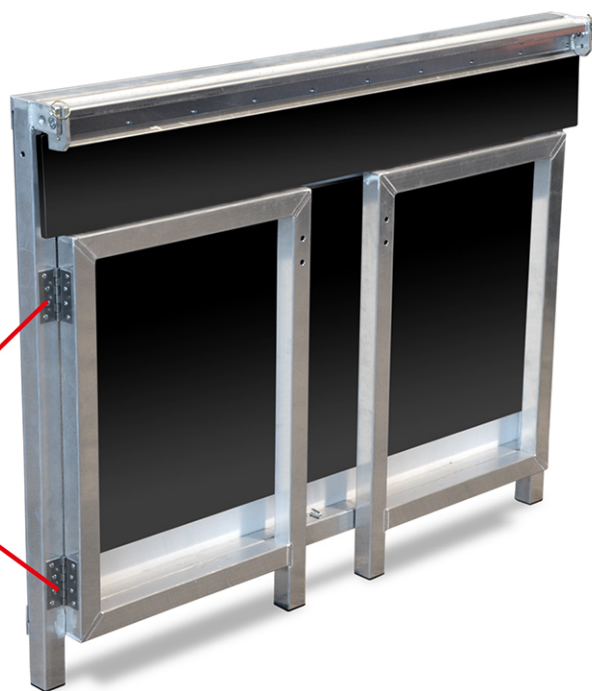

13,5 cm

- Transportmaß
- transport size
- taille de transport
- dimensione Trasporti





- Massiv gefertigte Edelstahl Scharniere
- solid stainless steel hinges
- charnières en acier inoxydable
- cerniere in acciaio inox massiccio









-  Fachboden (herausnehmbar)
-  shelving (removable)
-  tablette (amovible)
-  ripiano (removibile)



-  Flaschensumpf
-  bottles swamp
-  Marais de bouteilles
-  Palude di bottiglia

-  Seitenfüllung
-  side filling
-  remplissage latéral
-  riempimento laterale



Speedrack







①



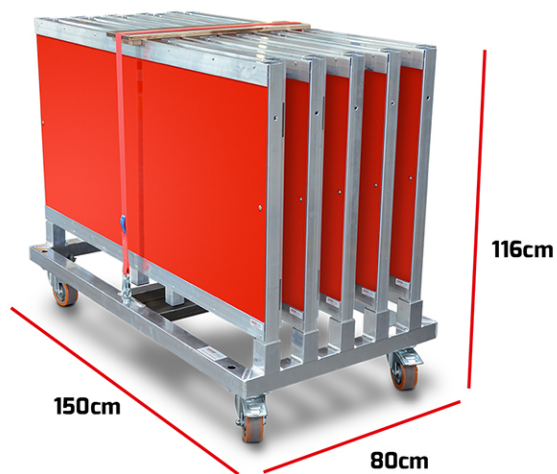

②

③

F.



-  einschiebbare Frontplatte (seitlich herausnehmbar)
-  Removable front plate (sideways removable)
-  Panneau frontal insérable (retirable latéralement)
-  Piano frontale inseribile (estraibile lateralmente)

-  Transportwagen 5er Paket
-  Transport carriage 5 times package
-  Chariot de transport, lot de 5
-  Carrello da trasporto Pacchetto da 5

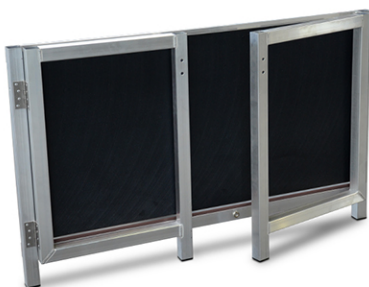

①



②







③





**= genaues Maß: 149cm









Schweißverbindungen nach ÖNORM EN ISO 9606-1/2

-  Arbeitsplatte aus hochverdichteten Kunststoffplatte
-  Highly-compressed plastic plate worktop
-  Comptoir en panneaux plastique haute densité
-  Piani di lavoro realizzati con robuste lastre di plastica altamente compresse





-  Kunststofffüße
-  plastic feet
-  Piedsen plastique
-  Piedini in plastica

-  Gewicht: 36 kg
-  weight: 36 kg
-  Poids: 36 kg
-  peso: 36 kg

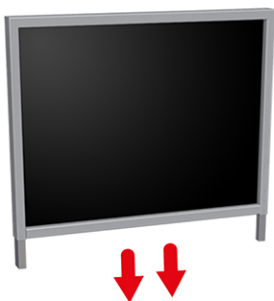



-  ALUVERBUND-Frontplatte zum einfachen austauschen
-  Aluminium composite front panel for simple change
-  Panneaux avant en aluminium composit pour simple échange
-  Pannello frontale composito in alluminio per semplicemente scambio

-  Aluminium Sonderprofile mit abgerundete Kanten
-  Aluminium special profile with rounded edges
-  Profilé spécial en aluminium avec bords arrondis
-  Profilo speciale in alluminio con









-  klappBAR Rückwand
-  klappBAR rear panel
-  paroi arrière klappBAR
-  parete posteriore klappBAR







-  Alu-Konstruktion Pulverbeschichtet in über 200 RAL Farben möglich
-  construction aluminium powder-coating in over 200 RAL colours possible
-  Recouvrement par poudre selon carte des coloris RAL
-  Verniciato a polvere secondo la scheda dei colori RAL







-  ALUVERBUND-Frontplatte zum einfachen austauschen
-  Aluminium composite front panel for simple change
-  Panneaux avant en aluminium composit pour simple échange
-  Pannello frontale composito in alluminio per semplicemente scambio





-  Fachboden (herausnehmbar)
-  shelving (removable)
-  tablette (amovible)
-  ripiano (removibile)

-  Kunststofffüße
-  plastic feet
-  Piedsen plastique
-  Piedini in plastica







-  Beleuchtung links und rechts LED 24V Neutralweiß
-  front lighting left and right LED 24V white
-  Eclairage front à droite et à gauche LED 24V blanc
-  Illuminazione frontale a destra e sinistra con LED 24V bianchi







-  Regalrückwände und klappBAR Tische auf Transportwagen
-  Shelving rear panels and foldable tables on transport carriage
-  Parois arrière étagère et tables klappBAR sur chariot de transport
-  Pareti posteriori degli scaffali e tavoli klappBAR sul carrello di trasporto







-  Komplette Rahmenkonstruktion
Pulverbeschichtet
-  Complete powder coating of frame
-  Châssis complet, recouvert par poudre
-  Struttura del telaio
completamente rivestita a polvere







-  Transportwagen 5er Paket
-  Transport carriage 5 times package
-  Chariot de transport, lot de 5
-  Carrello da trasporto Pacchetto da 5











-  Front mit Kunstleder überzogen
-  Front covered with leatherette
-  Devant recouvert de simili cuir
-  Anteriore rivestito in similpelle





TRANSPORTBOX





-  Transportbox für 1 klappBAR
-  Transport box for 1 klappBAR
-  Boîte de transport pour 1 klappBAR
-  Scatola di trasporto per 1 klappBAR







-  Transportmaß
-  transport size
-  taille de transport
-  dimensione Trasporti



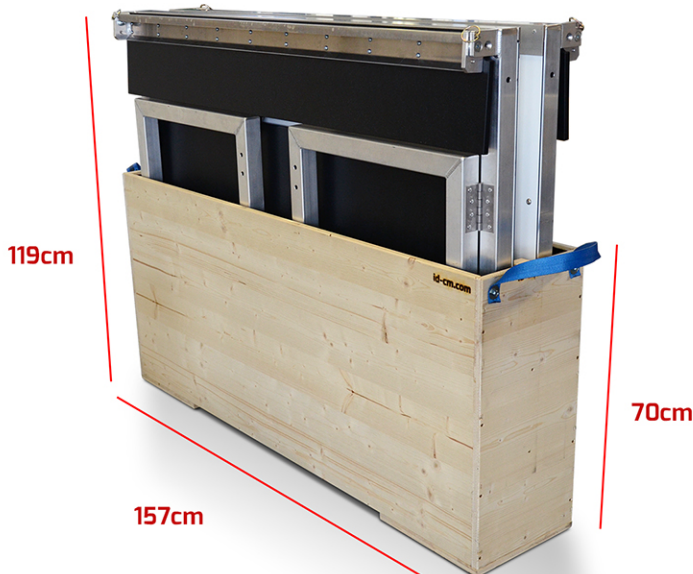

-  Gewicht mit klappBAR: 70 kg
-  weight with klappBAR: 70 kg
-  Poids avec klappBAR: 70 kg
-  Peso con klappBAR: 70 kg

-  Dreischichtplatte
-  Three-layer board
-  panneau en bois tricouche
-  pannello a tre strati in legno

-  Transportbox für 2 klappBARs
-  Transport box for 2 klappBARs
-  Boîte de transport pour 2 klappBARs
-  Scatola di trasporto per 2 klappBARe



-  Transportmaß
-  transport size
-  taille de transport
-  dimensione Trasporti

-  Gewicht mit 2 klappBARs: 118,5 kg
-  weight with 2 klappBARs: 118,5 kg
-  Poids avec 2 klappBARs: 118,5 kg
-  Peso con 2 klappBARe: 118,5 kg

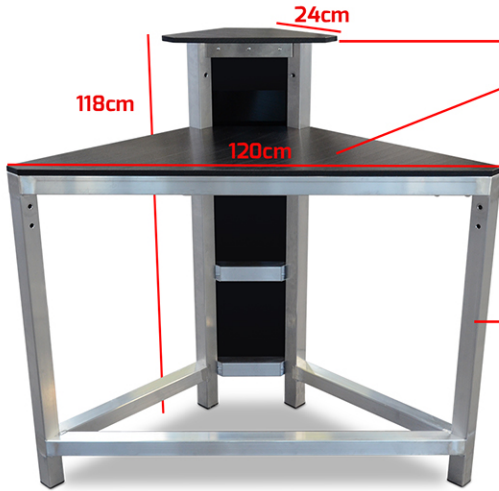

- Arbeitsplatte und Bord aus hochverdichteten Kunststoffplatten
- Highly-compressed plastic plate worktop and shelving
- Comptoir et bord en panneaux plastique haute densité
- Piani di lavoro e mensole realizzati con robuste lastre di plastica altamente compresse



- Alu-Konstruktion, Pulverbeschichtung in über 200 RAL Farben möglich
- construction aluminium powder-coating in over 200 RAL colours possible
- Recouvrement par poudre selon carte des coloris RAL
- Verniciato a polvere secondo la scheda dei colori RAL

- Frontplatte Abmaße
- dimensions of the front plate
- dimensions du Panneau frontal
- Dimensioni del Piano frontale

- Frontplatte Sichtmaß
- Visible dimensions of the front plate
- dimensions visible du Panneau frontal
- Dimensioni visibile del Piano frontale

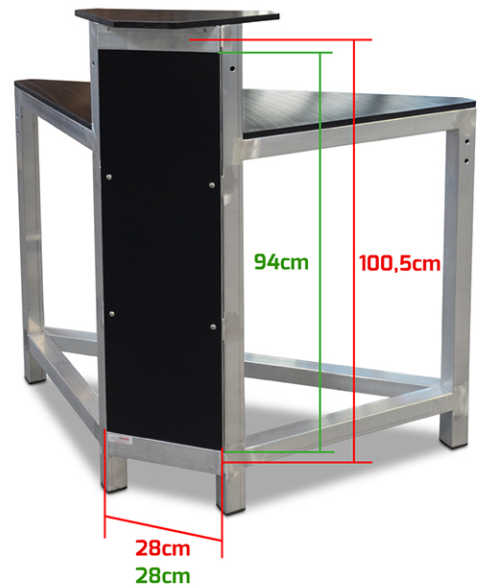

- Transportwagen 2er Paket
- Transport carriage 2 times package
- Chariot de transport, lot de 2
- Carrello da trasporto Pacchetto da 2

- Anwendungsbereich Innenecke
- Application inside corner
- champ d'application angle
- campo di applicazione angolo



- Draufsicht
- top view
- vue en plan
- vista in pianta



ECKELEMENT 90°

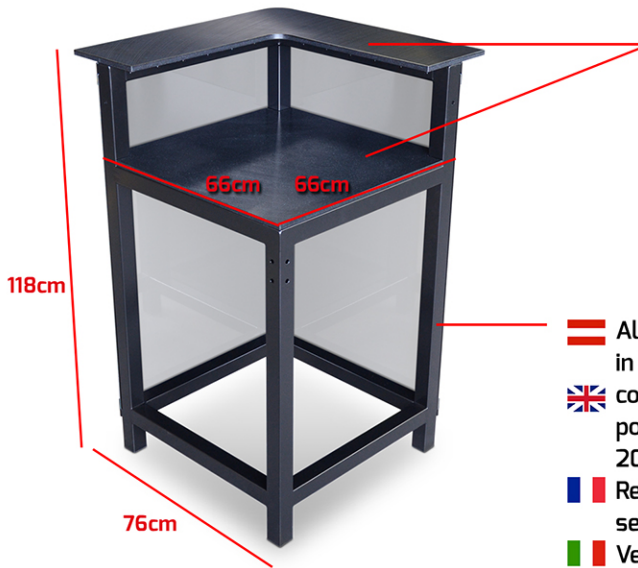

- Arbeitsplatte und Bord aus hochverdichteten Kunststoffplatten
- Highly-compressed plastic plate worktop and shelving
- Comptoir et bord en panneaux plastique haute densité
- Piani di lavoro e mensole realizzati con robuste lastre di plastica altamente compresse

- Alu-Konstruktion, Pulverbeschichtung in über 200 RAL Farben möglich
- construction aluminium powder-coating in over 200 RAL colours possible
- Recouvrement par poudre selon carte des coloris RAL
- Verniciato a polvere secondo la scheda dei colori RAL

- Frontplatte Abmaße
- dimensions of the front plate
- dimensions du Panneau frontal
- Dimensioni del Piano frontale

- Frontplatte Sichtmaß
- Visible dimensions of the front plate
- dimensions visible du Panneau frontal
- Dimensioni visibile del Piano frontale

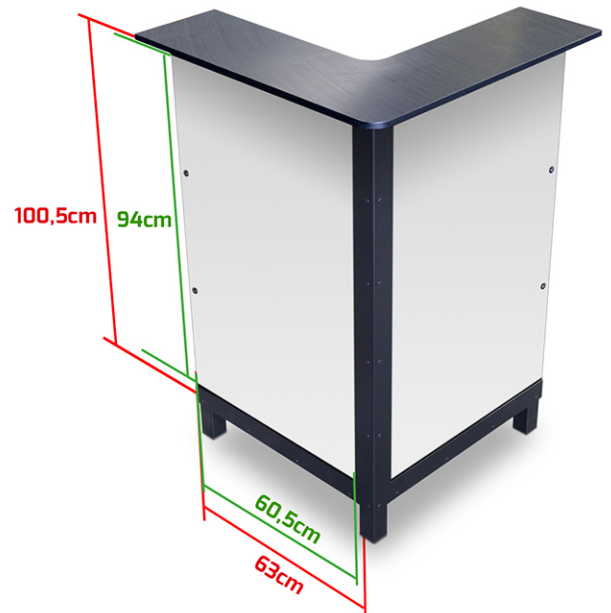

- Transportwagen 2er Paket
- Transport carriage 2 times package
- Chariot de transport, lot de 2
- Carrello da trasporto Pacchetto da 2

- Anwendungsbereich Ecke 90°
- Application corner 90°
- champ d'application angle 90°
- campo di applicazione angolo 90°

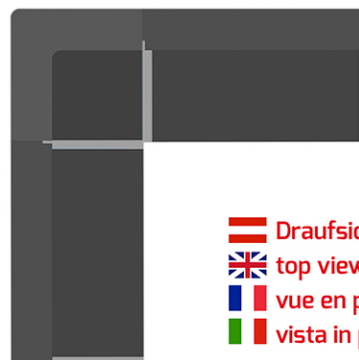

- Draufsicht
- top view
- vue en plan
- vista in pianta

ECKELEMMENT 45°

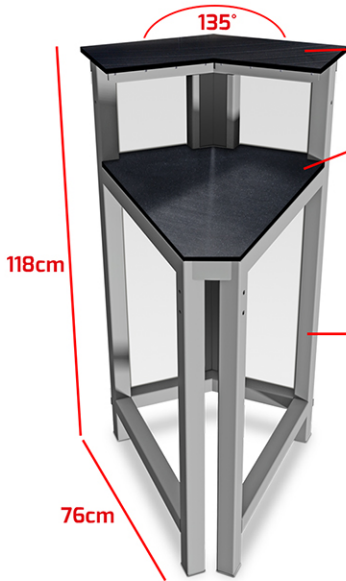

- Arbeitsplatte und Bord aus hochverdichteten Kunststoffplatten
- Highly-compressed plastic plate worktop and shelving
- Comptoir et bord en panneaux plastique haute densité
- Piani di lavoro e mensole realizzati con robuste lastre di plastica altamente compresse

- Alu-Konstruktion, Pulverbeschichtung in über 200 RAL Farben möglich
- construction aluminium powder-coating in over 200 RAL colours possible
- Recouvrement par poudre selon carte des coloris RAL
- Verniciato a polvere secondo la scheda dei colori RAL

- Frontplatte Abmaße
- dimensions of the front plate
- dimensions du Panneau frontal
- Dimensioni del Piano frontale

- Frontplatte Sichtmaß
- Visible dimensions of the front plate
- dimensions visible du Panneau frontal
- Dimensioni visibile del Piano frontale

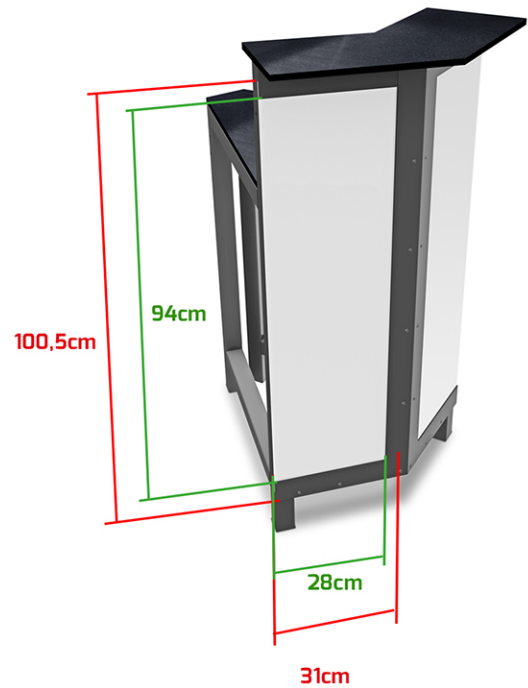

- Transportwagen 2er Paket
- Transport carriage 2 times package
- Chariot de transport, lot de 2
- Carrello da trasporto Pacchetto da 2

- Anwendungsbereich Ecke 45°
- Application corner 45°
- champ d'application angle 45°
- campo di applicazione angolo 45°

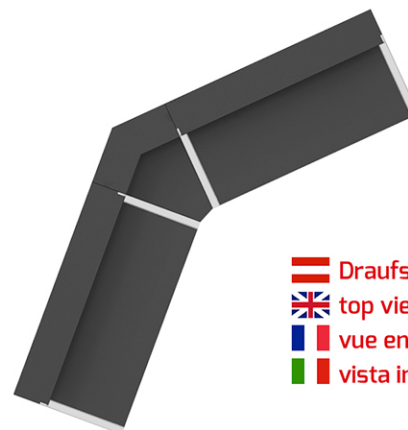

- Draufsicht
- top view
- vue en plan
- vista in pianta

ECKELEMENT 90°/45°

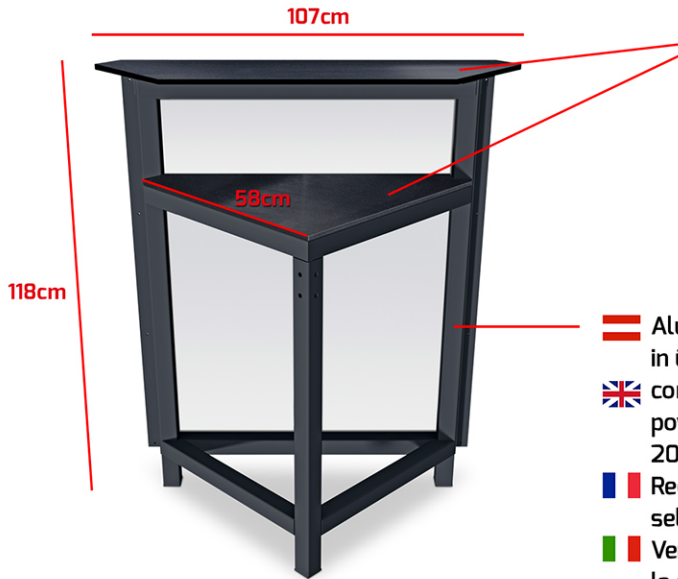

- Arbeitsplatte und Bord aus hochverdichteten Kunststoffplatten
- Highly-compressed plastic plate worktop and shelving
- Comptoir et bord en panneaux plastique haute densité
- Piani di lavoro e mensole realizzati con robuste lastre di plastica altamente compresse

- Alu-Konstruktion, Pulverbeschichtung in über 200 RAL Farben möglich
- construction aluminium powder-coating in over 200 RAL colours possible
- Recouvrement par poudre selon carte des coloris RAL
- Verniciato a polvere secondo la scheda dei colori RAL

- Frontplatte Abmaße
- dimensions of the front plate
- dimensions du Panneau frontal
- Dimensioni del Piano frontale

- Frontplatte Sichtmaß
- Visible dimensions of the front plate
- dimensions visible du Panneau frontal
- Dimensioni visibile del Piano frontale

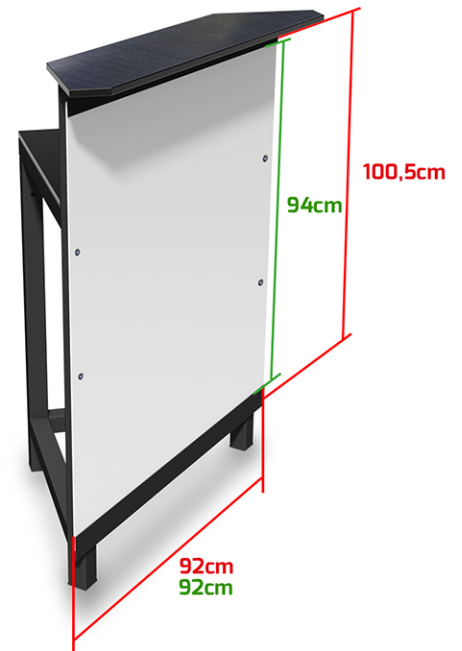

- Transportwagen 2er Paket
- Transport carriage 2 times package
- Chariot de transport, lot de 2
- Carrello da trasporto Pacchetto da 2

- Anwendungsbereich Ecke 90°/45°
- Application corner 90°/45°
- champ d'application angle 90°/45°
- campo di applicazione angolo 90°/45°



- Draufsicht
- top view
- vue en plan
- vista in pianta